

32" stroke - \varnothing 1/2 - 6" capacity

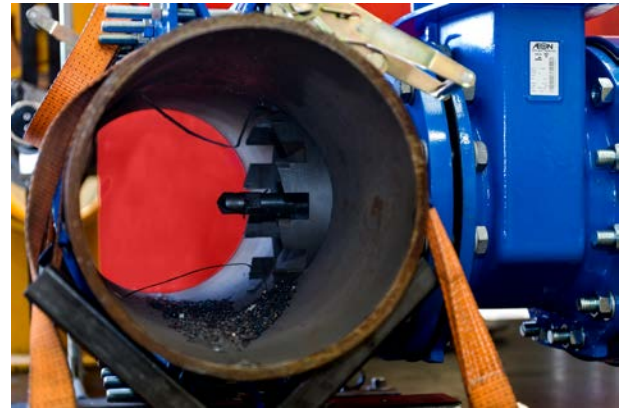

- **Manual rotation & feed**
- **2" NPT connection**
- **Lightweight construction**
- **Pressure 102 bar (1480 psi)**

Part of our HTM machine range, with a maximum working pressure capacity of 1480 p.s.i it can hot tap from \varnothing 1/2 - 6". Specifically designed for the water, gas and petrochemical industries.

The HTM150XL machine is supplied complete with:

- Toolkit
- Air filter lubricator (when required) and hose connection
- All required hole saw adapters and drive plates
- Storage / shipping box
- CE certificate
- Packing list and manual

Alternatively, you can purchase the complete HTM150XL SET which also includes additional tooling with the machine (see page 3).

Technical Details

Minimum Tapping Hole Diameter	12mm	1/2"
Maximum Tapping Hole Diameter	152mm	6"
Maximum Working Pressure	102 bar	1480 p.s.i
Maximum Operating Temperature	200°C	392°F
Spindle Bar Travel	813mm	32"
R.P.M (when motor driven)	0	200
Drive - Pneumatic (weight + 4 Kgs)	0.9 Hp	0.67Kw
Air Supply Required @ 90 p.s.i	42 s.c.f.m	1.19 m3/m

Feed Rates

Feed Rate - Manual / Revolution	3.0mm	0.118"
---------------------------------	-------	--------

Weights and Dimensions

Machine Weight	32 Kgs	70 Lbs
Shipping Weight	68 Kgs	150 Lbs





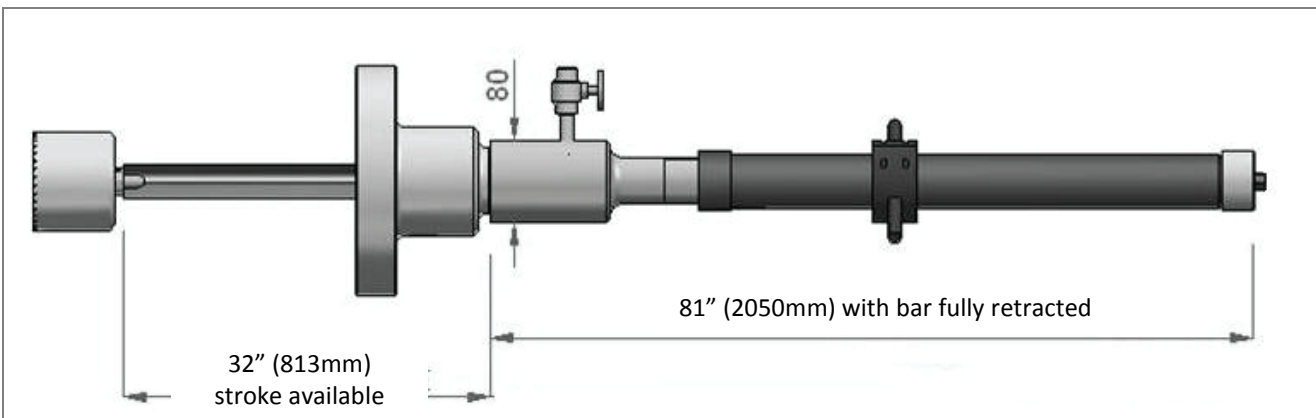

Shipping Dimensions

Length		Width		Height	
mm	inches	mm	inches	mm	inches
2070	81	400	16	350	14



Optional Accessories

Complete set for 1/2 - 6" #150 and #300 Hot Taps

Accessory	Part number	Description	Quantity
	HTM150XL	(1/2" - 6") HOT TAP MACHINE	1
	HTM1504	18" STROKE SHORT DRILL SHAFT	1
Flange adapters			
	TA2-2	2" NPT THREADED ADAPTER	2
	FA2#150	2" #150 FLANGE ADAPTER	1
	FA3#150	3" #150 FLANGE ADAPTER	1
	FA4#150	4" #150 FLANGE ADAPTER	1
	FA6#150	6" #150 FLANGE ADAPTER	1
	FA2#300	2" #300 FLANGE ADAPTER	1
	FA3#300	3" #300 FLANGE ADAPTER	1
	FA4#300	4" #300 FLANGE ADAPTER	1
	FA6#300	6" #300 FLANGE ADAPTER	1
Standard drills			
	HTMD1/2	1/2" STANDARD DRILL	1
	HTMD1	1" STANDARD DRILL	1
	HTMD1 1/4	1-1/4" STANDARD DRILL	1
	HTMD1 1/2	1-1/2" STANDARD DRILL	1
Hole saw tooling			
	HTMHSP2	2-3" HOLE SAW HOLDER & PILOT DRILL	1
	HTMHSP3	3-6" HOLE SAW HOLDER & PILOT DRILL	1
Hole saw cutters			
	HTMHS2	2" HOT TAP HOLE SAW	1
	HTMHS3	3" HOT TAP HOLE SAW	1
	HTMHS4	4" HOT TAP HOLE SAW	1
	HTMHS6	6" HOT TAP HOLE SAW	1